



REDEFINING  
THE WAY

■



User Manual

EQUATOR

Warning: Do not use electric leisure vehicles until you carefully read the user manual to understand their performance, And please keep the user manual properly.



## **Welcome to the DIMENTRO family !**

We are delighted that you have chosen the DME1 electric two-wheeler. To assist you in operating the DME1 correctly and safely, please follow our guidance below. Safety is paramount, so we urge you to read this manual thoroughly before using your vehicle and adhere to the following requirements:

- A. Gain a comprehensive understanding of the information provided in the manual, encompassing instructions, precautions, and warnings.
- B. Familiarize yourself with the operational procedures and emergency protocols.
- C. Take note of the warning labels affixed to the DME1.
- D. DIMENTRO will not be held responsible for any issues arising from unauthorized modifications, the use of non-original parts, or the installation of components that could impact performance and safety.
- E. Should you encounter any difficulties while using this electric vehicle, please reach out to your local dealers or distributors for assistance.
- F. DIMENTRO is committed to serving you. We hope you enjoy a pleasant journey!

## **Safety instruction**

To ensure your and others' safety, please adhere to the following guidelines meticulously:

A. Product Familiarization:

- Read this product manual thoroughly before use. Ensure you comprehend the product's characteristics and functionalities.

B. Road Safety:

- Obey all traffic rules and refrain from using smartphones while driving. This applies to all modes of transportation, including electric vehicles (EVs).

C. Original Parts Policy:

- It is strictly prohibited to use non-original components from third-party sources or to disassemble and modify the EV without authorization. Any loss or damage incurred due to such actions will be solely your responsibility, and DIMENTRO will cease all guarantees for this EV.

D. Product Variations:

- Keep in mind that due to continuous improvements, the EV you receive may slightly differ from the descriptions in the manual. Therefore, always refer to your actual EV for accurate information. For any uncertainties regarding usage, maintenance, or assembly, please contact our dealers or distributors.

E. Personal Protective Equipment (PPE):

- For your safety, wear a helmet, gloves, and other necessary protective gear while driving this product. Avoid loose clothing, as it can compromise your safety and comfort.

F. Pre-Ride Check:

- Before embarking on your ride, ensure that you are physically fit and well-rested. Avoid driving when

fatigued to maintain optimal control of the product.

G. Weather Precautions:

- In rainy or snowy or other extreme weather conditions, reduce your speed. Additionally, increase your braking distance when necessary to ensure safety.

H. Parking Regulations:

- Do not park electric motorcycles in lobbies, escape stairs, life passageways, or safety exits. These areas are reserved for emergency use only.

I. Charging & Storage:

- Never charge or park your EV inside residential buildings. When charging, ensure the electric motorcycle is situated away from combustible materials. Promptly disconnect the charger once the battery is fully charged to prevent overcharging.

## Product Parameters

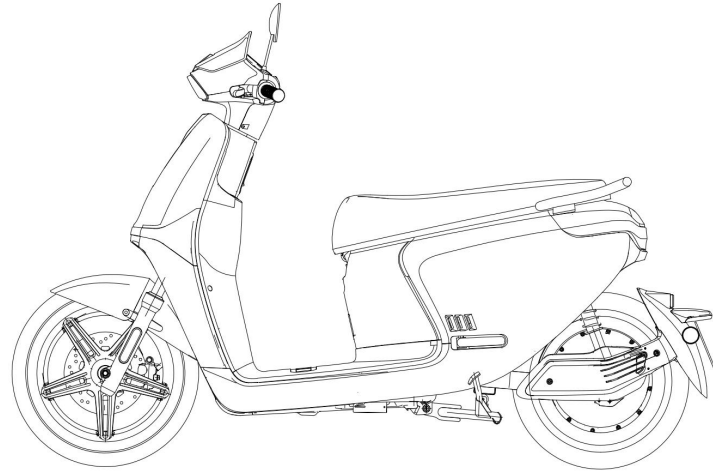

Model Name	DM-E1
Homologation	EEC(EU)-L1e
Max Speed	45km/h
Max Range	180km(Two batteries)
Max Climb Capacity	14
Max loading Weight	241 kg
Waterproof level	IP65
Battery Type	Re-moveable NCM Lithium

Battery Cell	Samsung 21700
Battery Capacity	72V30Ah(2.16Wh)
Battery Weight	14.5kg
Second Battery	√
Motor Type	Hub Motor
Motor Rated Power	3.0 kw
Motor Peak Power	4.0 kw
Max Torque	145 N.m
Controller Type	FOC
Charger Input Voltage	220V/110V
Charger Power	72V10A(Optional fast charger 15A)
Charging Time	3h(Optional 2.5h)
Unlocking Type	Remote control+Key
Brake type	CBS
Display type	TFT
USB	√
Vehicle Size	1970*705*1215 mm
Ground Clearance	133 mm
tire Size	Fr.100/80-14 / Re. 110/70-13
Tire pressure monitoring	×
Communication Protocol	CAN-bus

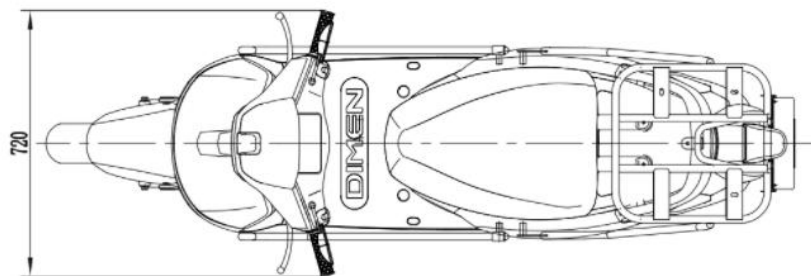
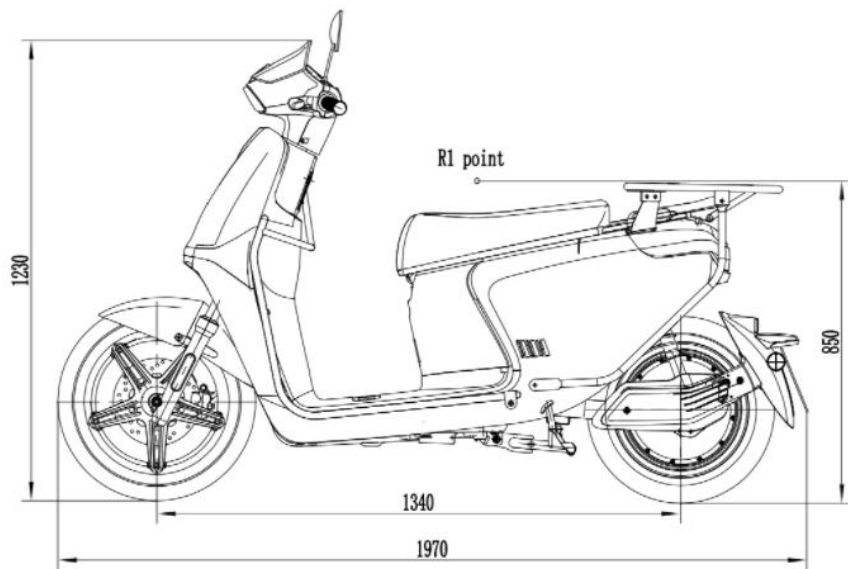

# Components instruction

## A. Description of Components

- ① Wind shield
- ② Headlight
- ③ Handlebar
- ④ Front cover
- ⑤ Turn signal
- ⑥ Front fender
- ⑦ Front wheel assy
- ⑧ Tool box cover
- ⑨ Pedal plate
- ⑩ Center cover
- ⑪ Cushion
- ⑫ Side cover
- ⑬ Armrest/Rear bracket
- ⑭ Main stand
- ⑮ Side stand
- ⑯ Rear wheel assy
- ⑰ Rear shield
- ⑱ Swingarm

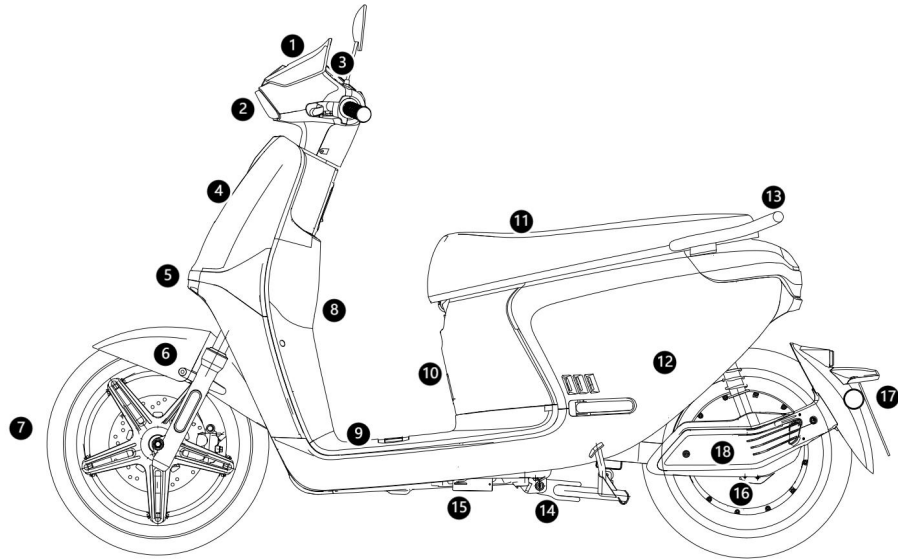

- ① Left handle grip
- ② Throttle grip
- ③ TFT
- ④ Left guard
- ⑤ Right guard
- ⑥ Rear rack

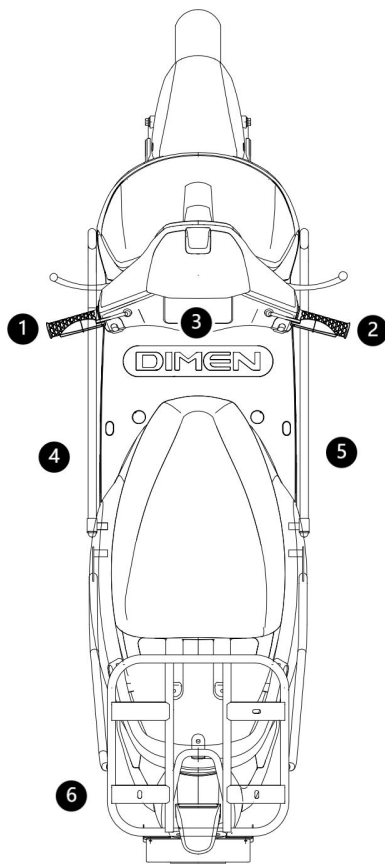

## B. Instrument

This Manual is for reference only. The instrument may be different from that described in this manual due to system version upgrade. The actual version shall prevail.

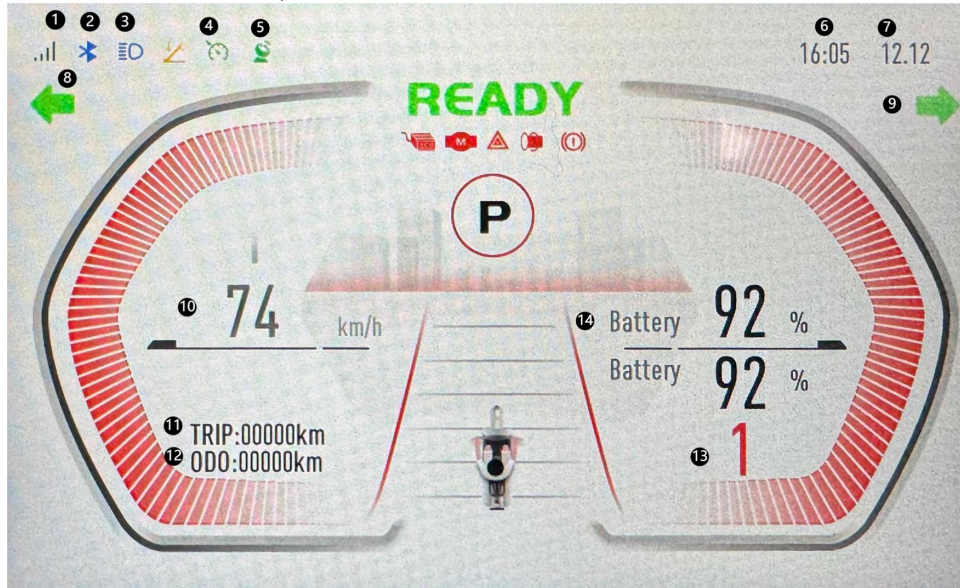

Day mode

①Signal ②Bluetooth ③High beam ④Cruise control ⑤GPS ⑥Time ⑦Date ⑧Left turn signal ⑨Right turn signal ⑩Speed ⑪Trip ⑫ODO ⑬Gear ⑭Battery charge

## EV Setting

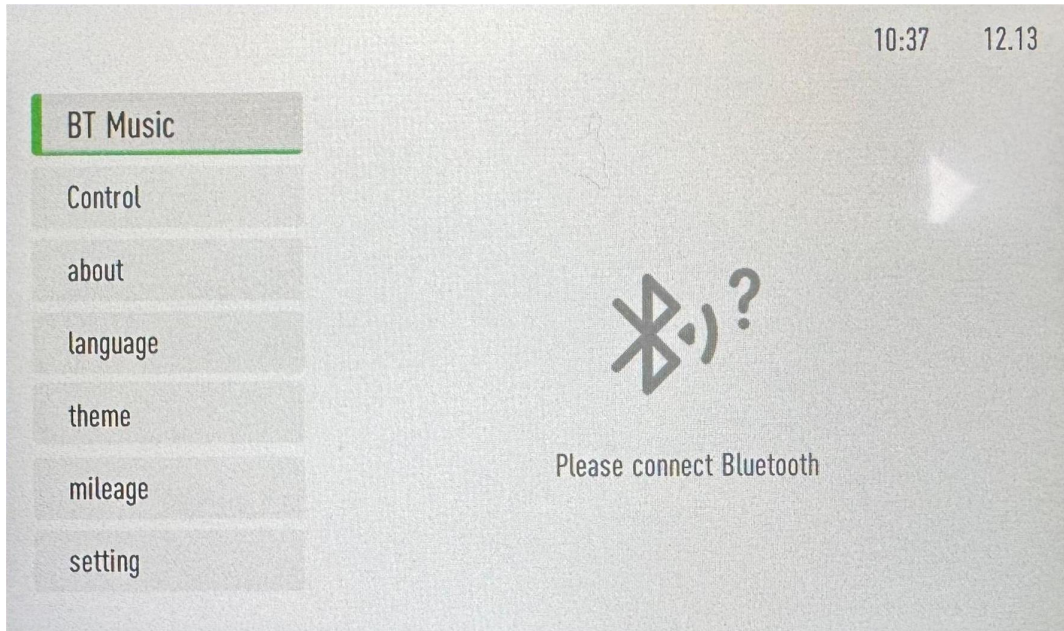

Bluetooth: Use you phone to connect the display by bluetooth, than the display can show coming calls

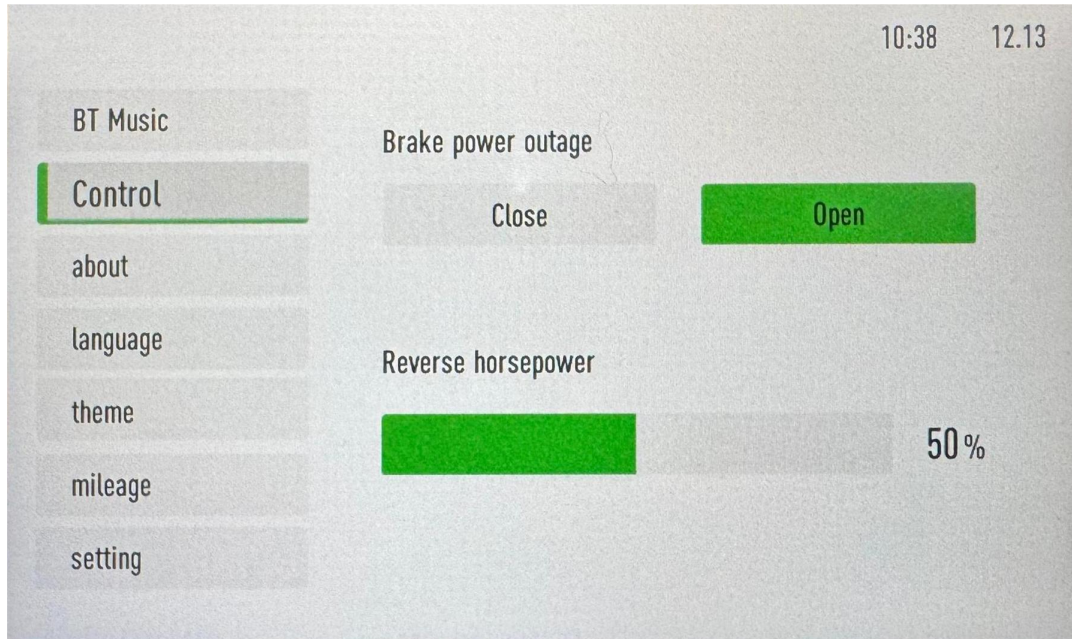

Control: Set the brake power outage on or off. And select the reverse horsepower

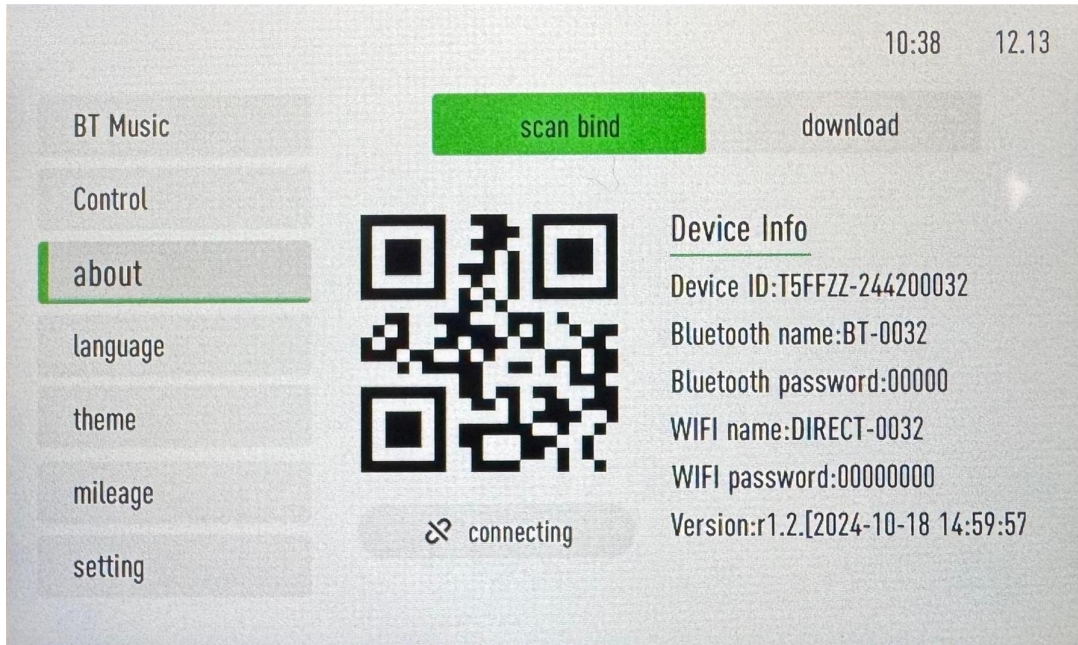

About: Scan the QR code on “DOWNLOAD “ and install the APP, connect the bike by use the APP to scan the code on “ SCAN BIND”. The phone can share the screen to the display by the APP.

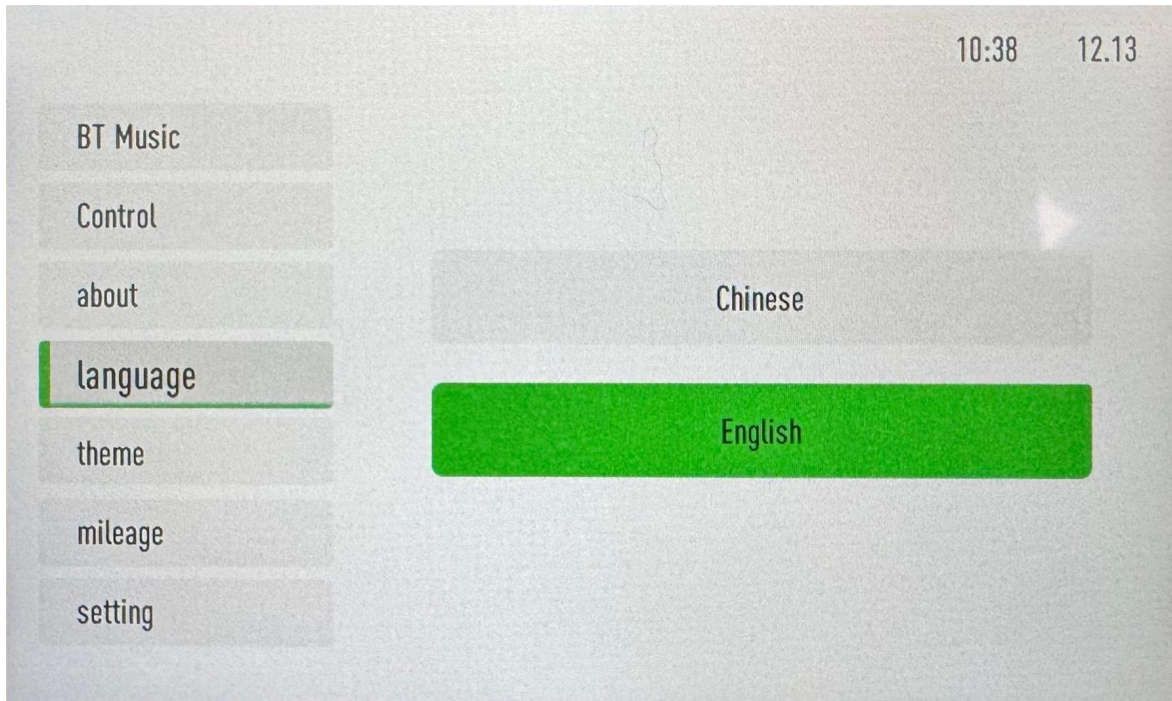

Language: Choose English or Chinese

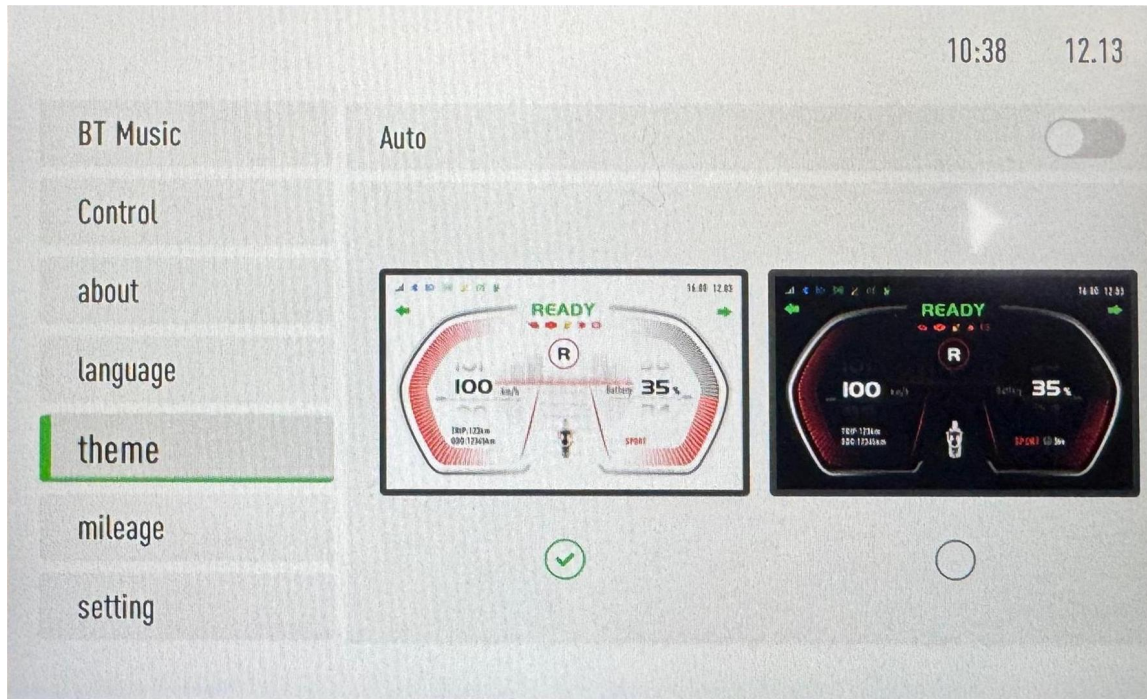

Theme: Choose daylight or night mode, or Auto mode

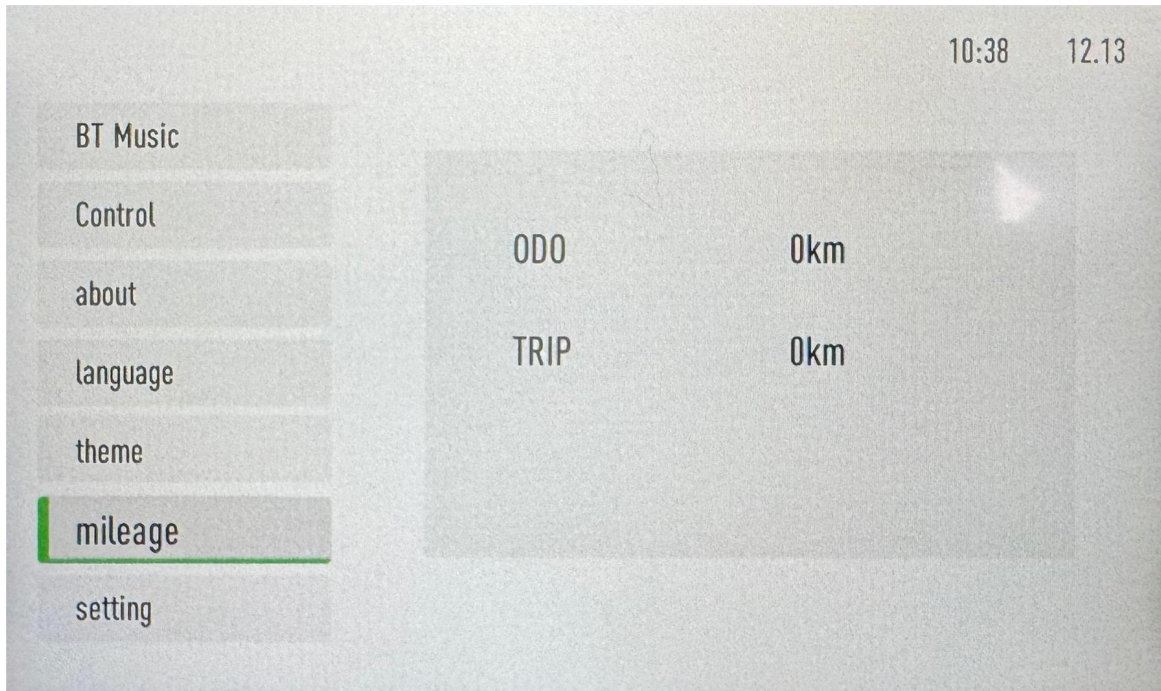

Mileage: It can show the the ODO and Trip, you also can reset the Trip in this page

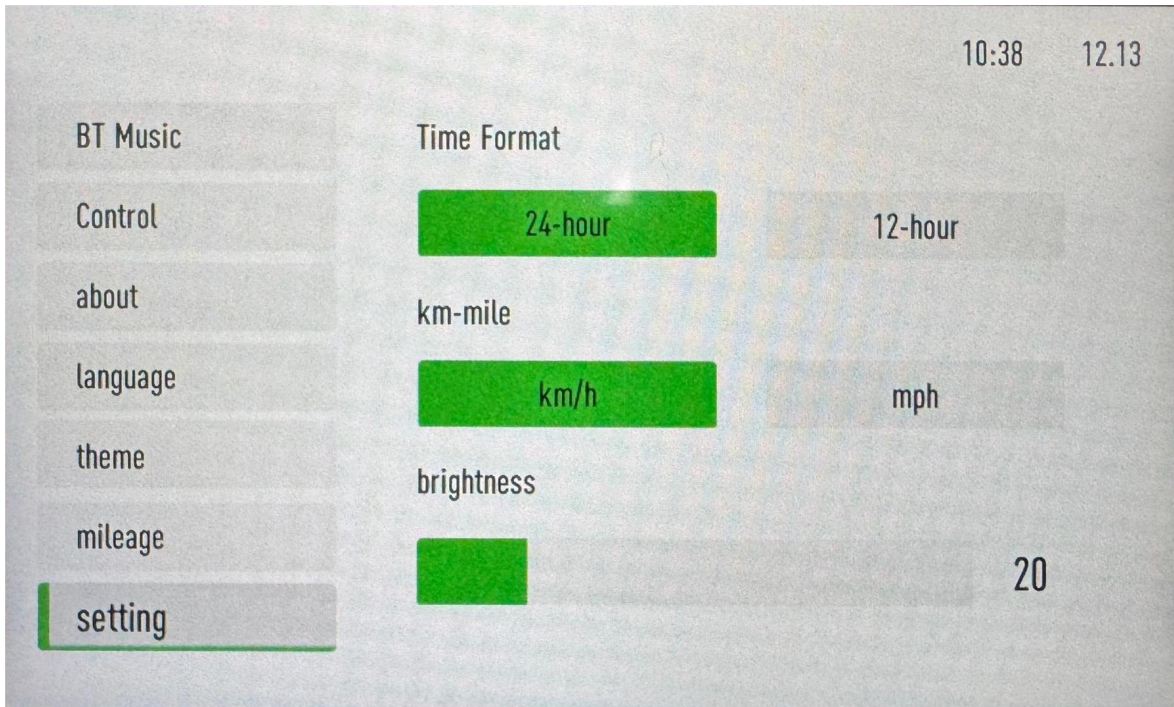

Setting: you can set time format, km-mile, brightness in this page

### C. Switch assy

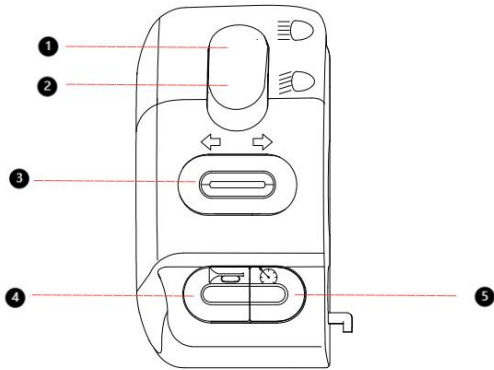

- ① High beam
- ② Low beam
- ③ Turn signal
- ④ Horn
- ⑤ Cruise control

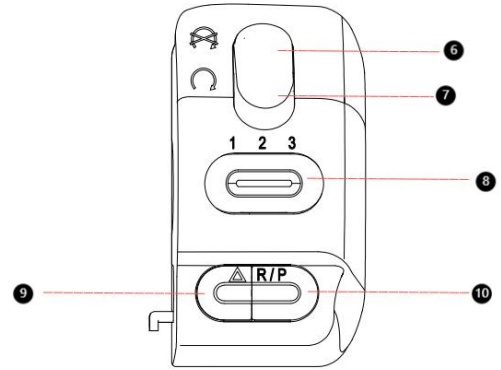

- ⑧ Gear
- ⑨ Double blinking
- ⑩ Park/Reverse

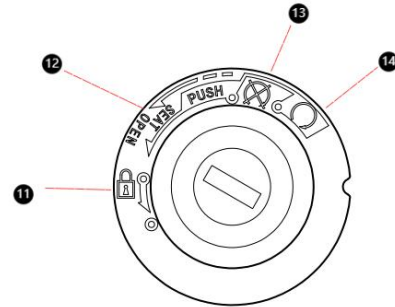

- ⑪ Lock
- ⑫ Open the seat
- ⑬ Power off
- ⑭ Power on

## D. Battery

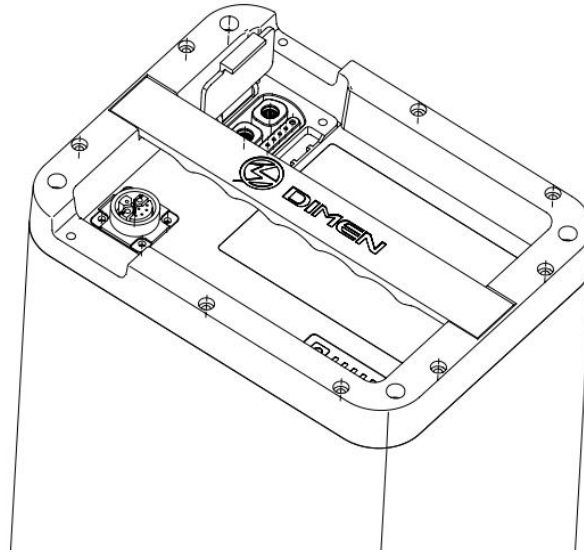





Open the cushion, take out the storage box, remove the connector from main harness, then take out the battery. The charger should be connected to battery first, then connected to power supply. If both the indicators on the charger and battery can light up, so charging is working.

## Battery use precaution

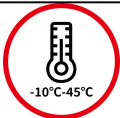
- Before charging, ensure the battery is original, don't use other brands and different types batteries;
- Ensure that the battery is in good station, no damage、leakage、overheat、water penetration、smoke etc;
- When using the battery for the first time, please do a full cycle before normal use to ensure that the actual capacity of the battery is as accurate as the power displayed on the mete;
- When daily use, please keep the battery power above 20% and charge it in time to extend the battery life;
- When daily use, it is not recommended to often drive the EV extremely, it can damage the battery;
- After the battery is used for a period, the actual capacity of the battery will deviate from the power displayed on the meter. Fully charge and discharge the battery regularly (no more than 3 months). The internal BMS system can balance the cells and calibrate the data automatically;
- It is recommended to check the battery socket and plug of the battery every two months to see whether the contact reed has carbon accumulation and oxidation (blackening). If these phenomena occur, please contact the dealers for repair;
- Batteries must not be rained or washed with water, nor soaked in water. If the EV wades, the water level shall not exceed the height of the battery bottom, otherwise the water will get into the battery, causing short-circuit and permanent failure of the battery. In this case, it is forbidden to recharge the EV or the battery, otherwise the battery may catch fire, burn or explode. Please take the battery to the dealer immediately for repair;
- For shipping safety, keep the charge is around 50% (30% by air). Since uncertain shipping/storage period and self consumption, please charge then in time after you receiving;
- If the battery connected to the EV, the EV itself will consume power, especially Alarm(about 3% / day), it is normal;
- If the EV/battery is needed to be stored for a long time, turn off the air switch or unplug the battery;
- If the EV/battery is needed to be stored for a long time, keep the ambient temperature of warehouse in Store the battery in 0°C~25°C, dont store the battery over 40°C, or the health of the battery will decay irreversibly;
- If the EV/battery is needed to be stored for a long time, it is recommended to keep the battery charge at 50%. if too full or too low, may cause the battery drained or chemistry damaged;

- Following is the technical standards of the self-consumption protection mode for the safe storage of lithium batteries:
  - if the battery is not used for a long time, it can be stored in the EV (battery plug is not unplugged), the maximum safe storage time is 15 days, otherwise it may cause the battery to feed and cannot be restored.
  - If the battery is not used for a long time, the power is not less than 50%, and is placed in the EV (unplug the battery), the maximum safe storage time is 2 months, otherwise it may cause the battery feed and cannot be restored.
- Do not store the battery in a place where there is a risk of falling;
- The battery is not covered with warranty by improper maintenance.

 -10°C-45°C			
Battery use condition:-10°C-45°C	Avoid soaking the battery in water, beverages, and corrosive liquids or other liquids.	Prevent the battery far from heat sources, flames, and flammable and explosive gases (liquids).	Avoid metal material getting into the battery

At low temperatures, the available capacity of the battery will decrease inordinately. For example, the available capacity is 70% at -10°C, 85% at 0°C, and 100% at 25°C.



If abnormal conditions such as odor, overheating, and deformation occur, stop using the battery immediately, put it in open area, step away from the battery, and contact the dealer.

The battery is not a component that users can repair. If anything abnormal occurs, contact the dealer.

If the battery is disassembled without authorization, the user will not be able to enjoy the warranty service, and the battery may overheat, smoke, fire or explosion.

## Charger use precautions

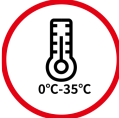
- Only can be used indoors;
- Do not charge the battery in a confined place or with high ambient temperature. Do not put the charger in barrel or truck when charging;
- When charging, connect the charger to power supply first, then battery; when stop charging, disconnect the power supply first, then battery;
- When charging to full, disconnect the charger in time, forbid to connect the charger and battery for a long time;
- When charging, stop immediately if odor, smoke and indicator flashing abnormal, contact dealer or after-sales center;
- Do not disassemble or repair the charger without authorization;
- When replacing the charger, make sure the new charger can match the battery;

		
<p>Please use the original charger to charge the battery, do not use other brands or different types of chargers to charge the battery.</p>	<p>Charge the battery at an ambient temperature of 0°C to 35°C.</p>	<p>Do not charge the battery for more than 8 hours; otherwise, the service life of the battery will be affected.</p>

- Early charging speed is fast, late charging speed is slow, this is because the logic set for charging safety, this is normal;
- In winter, if the outdoor temperature is low, below 0 °C, the charging will be suspended, which is a normal phenomenon. Please charge at the appropriate ambient temperature to ensure the charging efficient.

In the charging process, aluminum shell on the chargers will produce thermal effect, the surface temperature is high, this is a normal phenomenon, please rest assured to use, and avoid children touching the charger.

## Quick start

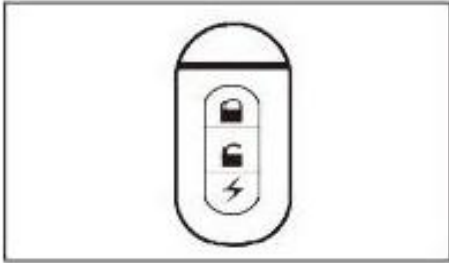

① Press 'UNLOCK' on remote control

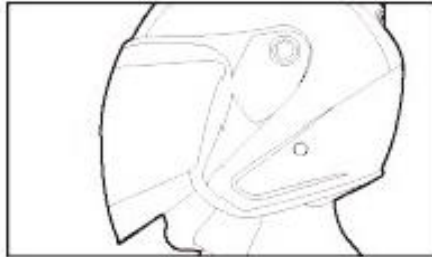

② Wear the helmet

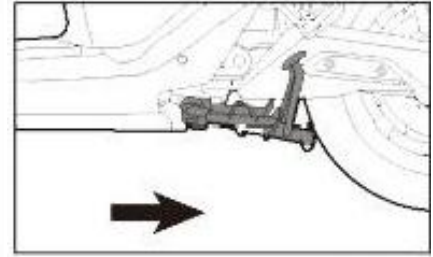

③ Lift the side stand

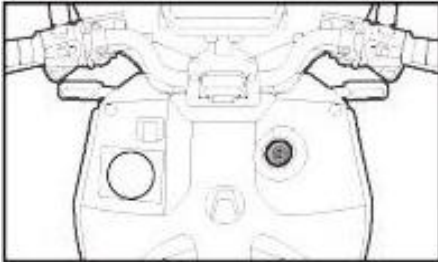

④ Turn the key to ON position

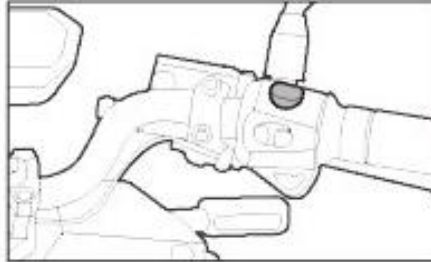

⑤ Press "Parking" to unlock the bike

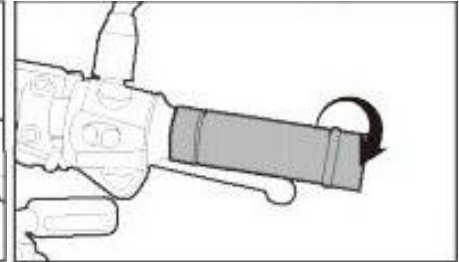

⑥ Turn the accelerator gently and be aware of your surroundings

# Riding Guidance

## A. Preparations and precautions

- Keep drunk away from driving;
- Driving skills are necessary, whatever if you already skilled at other EVs, please spend some time to familiar with DME1;
- We require all drivers to take THE driving courses certified by the local government and get relevant certification;
- If it is first time for you to drive this product, we strongly urge you to read the user manual carefully;
- Confirm that you have fully understood all safety information;
- Understand all the functions of the EV;
- Please make sure that you are healthy and in good condition;
- Helmet, goggles and riding clothing are necessary, they can help you reduce hurt when accident;
- Don't drive after drinking or taking drugs.

## B. Checking before riding

- When it is first time you receive this product, check the EV carefully. Anything damaged or no function, contact dealer for help.
- Before riding, check the items as following
  - Check whether the throttle rotates stably and flexibly.
  - Check whether the left/right switches can work properly;
  - Make sure the tire pressure is correct. Recommended tire pressure: Front: 250kpa (36psi); rear: 250kpa (36psi) for the rear wheel.
  - Check if the tire surface is clean and in good station. No breaks, damage, wear, or foreign objects piercing or sticking to other objects.
  - Tread depth is sufficient ( $> 0.8\text{mm}$ ).
  - Whether the engine check light is shown on the dashboard.
  - Whether the battery is in good state.

- Whether headlights, taillights, stop lights and turn signals work properly.
- Whether the horn is working properly.
- Rear mirrors are clean and adjusted to the proper angle.
- Whether the brake oil is sufficient, and whether the brake handle and brake system can work properly.
- Anything wrong or abnormal, please contact dealers.

### **C. Road condition and driving guidance**

- Precaution: Overloading or improper loading may affect this products performance, resulting in serious casualties. Please comply with all load limits and other load information in this manual.
- Loading: The DME1 has a maximum capacity of 264 kg, including the weight of the driver, passengers and all EV itself. DME1 should be used for you and your passengers first. However, if you want to load more, we recommend using a saddle bag. Please consult your dealer for the correct loading method and capacity range for the DME1. Incorrect loading may affect the stability and handling of the DME1. Even if the DME1 is loaded correctly, you should drive within a safe speed.
- When loading, please observe the following rules:
  - Check both front and rear tires in good state;
  - If you change the normal loading capacity, it may be necessary to adjust the way the cargo is hung;
  - In order to prevent the goods from loosening, please ensure that all goods are securely tied;
  - When loading, try to make the center g gravity is alignment with the center of gravity of the EV;
  - Distribute the weight of the goods evenly on both sides of the body.

### **D. Braking**

- Before driving the EV, it is necessary to check whether brake handles can work properly.
- Braking too hard may cause the wheels blocked and slipping sideways, and reducing control of the motorcycle. In this case, release the brake handle, continue driving forward until you regain the control, and then tap the brake again. EV equipped with CBS can better distribute braking force, EV equipped with

TCS can avoid the wheel to be blocked and regain control. Even if the EV you are driving equipped with CBS and TCS, you should still use the brakes reasonably according to the road conditions to avoid some special cases, electronic assistance system failure, resulting in safety problems.

- Slow down as much as possible before turning. Avoid braking while turning, as braking may cause one or both wheels to slip, reducing control of the motorcycle.
- The ability to turn and brake in emergency situations is an important driving skill. We recommend attending some motorcycle training courses to master these skills.
- When driving on wet, rainy or soft ground, the motorcycle's maneuverability and braking ability will be reduced. In this situation, should slow down the speed; Sudden acceleration, braking or cornering may cause the motorcycle to lose control. For your safety, please brake, accelerate, or turn carefully. Even when driving a EV equipped with TCS, you should still slow down to avoid rapid acceleration and deceleration, in order to avoid the failure of the electronic assistance system in some special cases, causing safety problems.
- On long steep slopes, frequent intermittent use of the brake or continuous braking may overheat the brake and reduce its working effect.
- When riding, if the hand is on the brake handle for a long time, it may turn on the stop light by mistake and send out wrong signals to other drivers; It may also overheat the brakes, reducing braking effectiveness

## **E. Parking**

- Drop the side stand, the icon "READY" on the instrument will disappear. You can power off the bike by NFC/Bluetooth/APP/key.

Do not park electric motorcycles in lobbies, escape stairs, life passageways, or safety exits. These areas are reserved for emergency use only.

## Maintenance

### A.Maintenance list

Maintenance list	Mileage/Time ( which occur first)							
	500 km/1 month	1000km/2 months	4800 KM/6 months	9600km / 12 months	14400 km/18 months	19300 km/24 months	24100 km/ 30 months	
Throttle	√	√	√	√	√	√	√	√
Front brake system	√	√	√	√	√	√	√	√
Rear brake system	√	√	√	√	√	√	√	√
Brake tubes and screws	√	√	√	√	√	√	√	√
Brake oil				√		√		√
All functional buttons	√	√	√	√	√	√	√	√
Lights	√	√	√	√	√	√	√	√
Side stand	√	√	√	√	√	√	√	√
Front suspension , front fork	√	√	√	√	√	√	√	√
Tighten parts	√	√	√	√	√	√	√	√
Tires	√	√	√	√	√	√	√	√

Wheel	√	√	√	√	√	√	√	√
Steering bearing	√	√	√	√	√	√	√	√
Battery	√	√	√	√	√	√	√	√
Motor	√	√	√	√	√	√	√	√

All check should be done by dealers authorized by DIMEN or distributors.

Maintenance list	Mileage/Time ( which occur first)	
------------------	-----------------------------------	--

### B. Clearing

- Before cleaning the EV, turn off the power and remove the battery.
- You can scrub the EV with a mixture of water and neutral detergent.
- After cleaning the vehicle, wipe the surface with a soft cloth.
- Do not use high-pressure water gun to wash the sides and interior of the body directly. Electronic components such as the charging socket and controller are located in the side cover above the pedal. Do not rinse directly.

### C. Storage

- Please store the vehicle in a flat, sturdy, ventilated and dry place. Please avoid sun and rain on the vehicle to reduce damage or aging of the components. For long-term storage of the vehicle, refer to the battery information in this manual.
- When the EV is used again after long-term storage, the battery should be fully charged.

## Troubleshooting

Phenomenon	Cause	Countermeasures
The EV cant be powered on	No power or control unit fails to work	<ol style="list-style-type: none"> <li>1. Check connectors are well connected</li> <li>2. Check battery ( indicator, BMS data)</li> <li>3. Check controller (indicator)</li> </ol>
The EV can be powered on, but motor can not rotate	<ol style="list-style-type: none"> <li>1. EV in braking</li> <li>2. EV in Parking</li> <li>3. Side stand not in correct position</li> <li>4. Start button fails to work</li> <li>5. Brake level not in correct position</li> </ol>	<ol style="list-style-type: none"> <li>1. Check if the EV in baking</li> <li>2. Down the side stand</li> <li>3. Contact aftersales for help</li> </ol>
Low range	<ol style="list-style-type: none"> <li>1. Low battery charge</li> <li>2. Low tire pressure</li> <li>3. Brake too often, overloading</li> <li>4. Cells in battery are decayed</li> </ol>	<ol style="list-style-type: none"> <li>1. Check if the charger in can work properly</li> <li>2. Check tires pressure before riding</li> <li>3. Be in good driving habits</li> <li>4. Replace the battery</li> <li>5. It is normal.</li> </ol>
Battery can not be charged	<ol style="list-style-type: none"> <li>1. Charger doesnt be plugged in position</li> <li>2. Temperature in battery is too low</li> <li>3. Temperature in battery is too high</li> <li>4. Check BMS data.</li> </ol>	<ol style="list-style-type: none"> <li>1. Check if the plug is loose</li> <li>2. Waiting for the battery back to chargeable temperature</li> </ol>
No power from USB	<ol style="list-style-type: none"> <li>1. The plug is not inserted to the socket well</li> <li>2. Cable is not up up to standard</li> </ol>	<ol style="list-style-type: none"> <li>1. Check if the plug well inserted to the socket</li> <li>2. Change the cables</li> <li>3. Contact aftersales for help</li> </ol>

## Definition of controller error code

<b>Definition</b>		<b>Blinking frequency</b>
Over-voltage protection	Battery voltage over setting	1
Under voltage protection	Battery voltage under setting	2
Over-current protection	Short circuit in motor phase lines or phase lines to the ground	3
Motor block protection	Motor blocked exceeds setting	4
Hall sensor protection	Hall signal abnormal	5
MOSFET protection	Abnormal situation was found when MOSFET self-checking	6
Open-phase protection	One of phase is open	7
Self checking protection	Abnormal situation is found when self-checking	10
High temperature protection on controller	Working temperature exceeds setting	11
Turn the car for protection	Signals from throttle is abnormal	12
High temperature protection on motor	Working temperature in motor exceeds setting	13
Throttle not in position	Re-operate the throttle and release it fully	14
Controller braking	Controller in braking	15

**MAINTENANCE RECORD:**

Content:

Date :

**MAINTENANCE RECORD:**

Content:

Date :

**MAINTENANCE RECORD:**

Content:

Date :

**MAINTENANCE RECORD:**

Content:

Date :

**MAINTENANCE RECORD:**

Content:

Date :

**MAINTENANCE RECORD:**

Content:

Date :

# Dimentro

<https://www.dimentro.com>

## **WUXI DIANMENG TECHNOLOGY CO.,LTD**

NO.268 HOUXIN ROAD, WUXI, JIANGSU, P.R.CHINA

E-mail: [info@dimentro.com](mailto:info@dimentro.com)

## **DIMEN FRANCE**

Cellule G9, Parc Dynamikun 78300 Poissy

E-mail: [longkai.w@dimentro.com](mailto:longkai.w@dimentro.com)

## **DIMEN INDONESIA**

Ruko Northridge Business Center, blok A3/2 and A3/3,

BSD City, Serpong-Tangerang 15331

E-mail: [marketing@dimen-indonesia.com](mailto:marketing@dimen-indonesia.com)